



PCB-AOC-DES Test Kit

User Guide

General Limited Warranty

CheckLight warrants the products manufactured by the Company, against defects and workmanship when used in accordance with the applicable instructions for a period not to extend beyond the product's printed expiration date. CheckLight makes no other warranty, expressed or implied. There is no warranty of merchantability or fitness for a particular purpose.

Copyright 2009 CheckLight Ltd

Table of contents

page

1- Introduction	5
What Is the Assimilable Organic Carbon (AOC) Assay?	5
How Does the Kit Work?	5
What is Included in the Kit	6
Reagents Provided	6
Equipment Required	7
2 - Preparing For the Assay	8
Important Factors That May Affect an Assay	8
Cleanliness	8
Accuracy	9
Reagent Freshness and Storage	9
Preparing the Carbon Cocktail Solution	9
Sample Collection and Storage	10
3- Assay Procedure	10
Outline of the Assay Procedure	11
Equipment and Reagents Required	12
Test Procedure 1- Standard	12
Add Assay Buffer to the Sample	12
Dilute the Sample	12

Prepare Negative Controls	12
Prepare Positive Controls	12
Optional Toxicity Testing	13
Prepare & Dispense Biosensor Bacteria	13
Incubate & Measure Luminescence	13
Calculate AOC	14
Scheme	15
Test Procedure 2- Micro plate format.....	15
Add Assay Buffer to the Sample	16
Dilute the Sample	16
Prepare Negative Controls	16
Prepare Positive Controls	16
Optional Toxicity Testing	16
Prepare & Dispense Biosensor Bacteria	16
Incubate & Measure Luminescence	16
Calculate AOC	16
Scheme	17
Estimating the concentration of AOC	18
Notes	19
4 - Troubleshooting	20
5 - Frequently Asked Questions	21

1-Introduction

About This Manual

This guide contains the instructions for how to use the PCB-AOC-DES Test Kit. The kit is easy to use and provides quick accurate results as long as the instructions are followed. It is therefore very important that you read and understand all of this guide **before** starting the assay.

If you encounter any problems while performing the assay read over **Important Factors That May Affect an Assay** on page 8, and find a list of problems that you may encounter in **Troubleshooting** on page 20.

What Is the Assimilable Organic Carbon (AOC) Assay?

The kit is for screening water from sources such as

- Brackish water
- Sea drinking water

How Does the Kit Work?

The test is based on the effect of assimilable organic compounds on the development of luminescence in *Vibrio fischeri*. The bacteria are given all the environmental and nutritional conditions necessary for light production, except an organic carbon source, instead of which the cells are exposed to the tested sample. The luminous bacteria are provided in a freeze-dried state. Upon hydration in the questioned water sample, these bacteria undergo prompt induction of the luminescence system if the sample contains assimilable organic compounds. Luminescence increases with time, with an intensity dependent on the concentration of the organic compound. Sub-ppm concentrations of different kinds of assimilable organic compounds can be determined within 2-3 hours.

What is Included in the Kit

The following materials are provided with the kit. Make sure that all are present before proceeding with the assay:

Reagents Provided

- 1 - Biosensor - stoppered vials holding freeze-dried luminous bacteria
- 2 - Hydration Buffer
- 3 - Concentrated Assay Buffer
- 4 - Diluted (ready to use) Assay Buffer
- 5 - Concentrated (X1000) carbon cocktail-standard solution (5 mg/ml)
- 6 - Empty vials

Equipment Required

- 7 - 10-1000 μ l pipettor and tips
- 8 - Repeat dispenser with 0.01ml aliquots (syringe or tip)
- 9 - Luminometer (minimum sensitivity of 1 fmol ATP)
- 10 - Temperature-controlled water bath
- 11 - Timer
- 12 - Vortex
- 13 - Clean water – Use nano-pure reference water that is <5ppb TOC, such as Milli-Q Element/Gradient/Synthesis Grade.



We recommend that you use the provided Excel module for rapid and simple data analysis.

2 - Preparing For the Assay

Important Factors That May Affect an Assay

The accuracy of the results can be affected by a number of factors. It is very important to keep these factors in mind while performing the assay.

Cleanliness

Due to the high sensitivity of the assay, care should be taken to keep all vials, plastic tips, and pipettes extremely clean. Keep in mind the following do and don't list:

Do

- Wash the plastic tips several times with clean water before use
- Work in a clean manner to keep the reagents from getting contaminated

Do not:

- Do not touch tips and inner side of tubes with bare hands to reduce the risk of contamination.
- Do not reuse the test vials
- Do not wash pipettors, pipette tips or glassware with detergent, acids or solvents. Use water only.

Accuracy

Due to the great sensitivity of the kit it is very important to add the reagents in exactly the right amounts. Therefore:

- Make sure that the pipette tip is firmly attached to the pipettor each time you add a reagent
- Before pipetting double-check that the pipettor is set to the correct amount.
- Check that there are no air bubbles inside the pipette tip.

Reagent Freshness and Storage

Make sure that all reagents are stored under appropriate conditions both in storage and after preparation.

Biosensor: a freeze-dried preparation of an isolated variant of the marine luminous bacterium *Vibrio fischeri*. The shelf life of this reagent is one year when stored in a deep freezer (-10°C to -20°C). Reagent should not be stored in a self-defrosting freezer, which defrosts by warming up periodically. Once hydrated in Hydration Buffer, the suspended cells can be used within 4 hours, if kept on ice or at 4°C.

Assay Buffers – the Assay Buffer is provided in two forms – concentrated (x8) and dilute (ready to use). The buffers, together with the Hydration Buffer, should be kept at 4°C and should not be frozen.

Preparing the Carbon Cocktail Solution

The 5 ppm Carbon Cocktail Solution must be prepared fresh daily

1. Add 0.1 ml of the 5 mg/ml (5000 ppm) stock into 0.9 ml diluted Assay Buffer (Solution A; 500 ppm).
2. Mix well by carefully pipetting up and down.
3. Prepare another tube with 0.99 ml of diluted buffer and dispense into it 0.01 ml from Solution A (Solution B; 5 ppm).
4. Mix well by carefully pipetting up and down. This is the solution to be used in the test.

Sample Collection and Storage

Use the standard method for sample collection (See Kaplan et al. *App. Env. Microb.* 59 (5): 1532-1539.1993). We strongly recommend that you pasteurize the sample (70°C for 30 minutes) soon after collection and keep at 4°C until tested.

3 - Assay Procedure

The assay is performed in the following steps:

1. Collect the sample
2. Set the incubator/water bath to 26°C
3. Prepare all reagents and equipment
4. Label 14 empty tubes
5. Mix concentrated Assay buffer and sample in first tube
6. Dispense diluted Assay Buffer to remaining 13 tubes
7. Perform dilution of sample into 6 tubes
8. Leave 3 tubes as negative controls
9. Prepare positive control dilutions in four remaining tubes
10. Hydrate biosensor bacteria
11. Add Biosensor to tubes
12. Incubate for 60-150 minutes
13. Read results
14. Calculate AOC value

Equipment and Reagents Required

- 14 empty vials
- 0.25 ml concentrated Assay Buffer
- 13 ml diluted Assay Buffer
- 1 ml carbon cocktail solution in working concentration
- One vial of freeze-dried biosensor bacteria
- Pipettor and tips
- Repeat dispenser
- Water bath or Incubator
- Vortex
- Luminometer
- Nano-pure reference water (<5ppb TOC), such as Milli-Q Element/Gradient/Synthesis grade

Test Procedure 1 - Standard

Label the tubes

Sequentially label 14 tubes (or 18 vials if you also want to perform toxicity testing, See: Optional Toxicity Testing, page 13 and place them in a rack.

Add Assay Buffer to the Sample

- Add 1.75 ml of the water to be tested to vial #1.
- Add 0.25 ml of concentrated Assay Buffer.
- Mix by vortexing.

Dilute the Sample

- Add 1 ml of diluted Assay Buffer to tubes #2 - #14
- Add 1 ml from the solution in tube #1 to tube #2
- Mix well
- Repeat this dilution step through vials #3, 4, 5, 6, and 7
- Discard 1 ml from tube #7

Prepare Negative Controls

- Leave tubes #8, 9 and 10 as negative controls (containing diluted Assay buffer only).
- Mix well

Prepare Positive Controls

- Prepare 1 ml of Carbon Cocktail Solution diluted in Assay Buffer to a final concentration of 5ppm.
- Dispense as follows:

Tube #	Amount (µl)	Final Concentration (ppb)
11	10	50
12	20	100
13	40	200
14	80	400

- Mix well

Optional Toxicity Testing

This is not a mandatory step, but it may be useful if you want to check if there are toxic compounds in the sampled water. The general principle of the AOC assay is that any carbon present in the water will cause the luminescence levels to increase. In toxicity testing the presence of toxins in the sample water will cause a **decrease** in the luminescence levels as compared to the four positive controls prepared in the previous step.

- Prepare four additional tubes
- Mix 3.5 ml of sample water and 0.5 ml of concentrated Assay Buffer in the first tubes.
- Dispense 1 ml from the first tube into each of the three remaining tubes.
- Add 10, 20, 40 and 80µl of the diluted carbon cocktail (5ppm) into the 1st 2nd, 3rd and 4th tubes, respectively.

Prepare the Biosensor Bacteria

- Hydrate the lyophilized bacteria by adding 0.5 ml of cold Hydration Buffer
- Vortex without the stopper. If lumps appear discard the vial.

Dispense Biosensor Bacteria & incubate

- Use a repeat dispenser to dispense 10 µl of the bacterial solution into all tubes. Incubate the tubes in a water bath with a set temperature of 26°C.

Measure Luminescence

- Measure the luminescence after 60-150 minutes (or when the tubes with the two lowest concentrations emit significantly higher luminescence (>2XSD) than the negative control).

Calculate AOC concentration

- Using the Excel spreadsheet record the results obtained and calculate the AOC concentration in the sample. See page 18 for details.

Test Procedure 1 - Standard

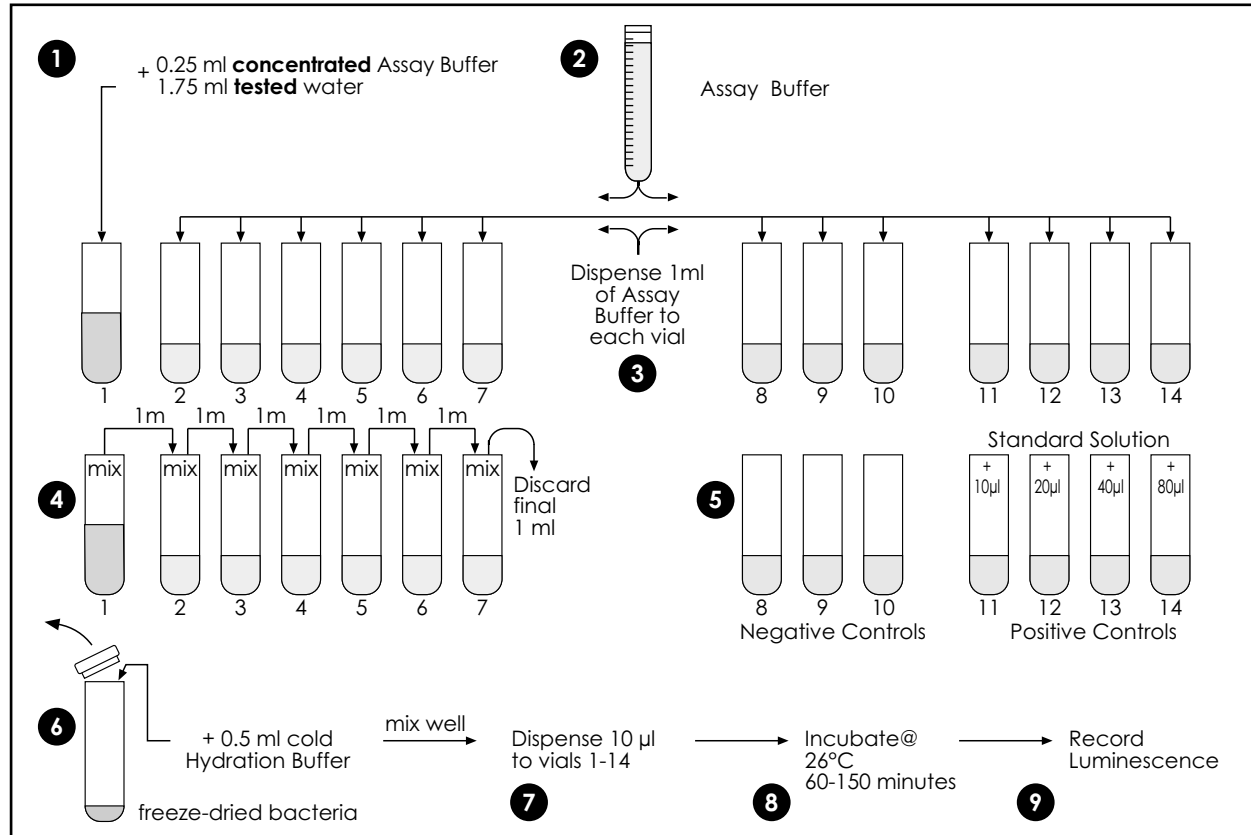

Test Procedure 2 – Micro plate format (Catalog number PCB-AOC-01-SMP)

Add Assay Buffer to the Sample

- Add 0.262 ml of the water to be tested to well #1.
- Add 0.037 ml of concentrated Assay Buffer.
- Mix by pipetting up and down 3 times.

Dilute the Sample

- Add 0.15 ml of diluted Assay Buffer to wells #2 - #14.
- Add 0.15 ml from the solution in well #1 to well #2.
- Mix well by pipetting up and down 3 times.
- Repeat this dilution step through wells #3, 4, 5, 6, and 7
- Discard 0.15 ml from well #7.

Prepare Negative Controls

- Leave wells #8, 9 and 10 as negative controls (containing diluted Assay buffer only).
- Mix well by pipetting up and down.

Prepare Positive Controls

- Prepare 1 ml of Carbon Cocktail Solution diluted in Assay Buffer to a final concentration of 5ppm.
- Remove from well #13 and well #14, 5 and 10 μ l, of buffer, respectively.
- Dispense as follows:

Well #	Amount (μl)	Final Concentration (ppb)
11	1	30
12	3	90
13	5	150
14	10	300

- Mix well by pipetting up and down 3 times.

Optional Toxicity Testing

This is not a mandatory step, but it may be useful if you want to check if there are toxic compounds in the sampled water. The general principle of the AOC assay is that any carbon present in the water will cause the luminescence levels to increase. In toxicity testing the presence of toxins in the sample water will cause a decrease in the luminescence levels as compared to the four positive controls prepared in the previous step.

- Prepare four additional tubes
- Mix 0.7 ml of sample water and 0.1 ml of concentrated Assay Buffer
- Dispense 0.15 ml into each of 4 wells.
- Add 1, 3, 5 and 10 μ l of the diluted carbon cocktail (5ppm) into the 1st 2nd, 3rd and 4th wells, respectively.

Prepare the Biosensor Bacteria

- Hydrate the lyophilized bacteria by rapidly adding 0.3 ml of cold Hydration Buffer.
- Add 0.7ml of Assay Buffer.
- Vortex without the stopper. If lumps appear discard the vial.

Dispense Biosensor Bacteria & incubate

- Use a repeat dispenser to dispense 10 μ l of the bacterial solution into all tubes. Incubate the micro plate within the plate reader (or air incubator) with a set temperature of 26°C.

Measure Luminescence



- Measure the luminescence after 60-150 minutes (or when the tubes with the two lowest concentrations emit significantly higher luminescence (>2XSD) than the negative control).

Calculate AOC concentration

- Using the Excel spreadsheet record the results obtained and calculate the AOC concentration in the sample.

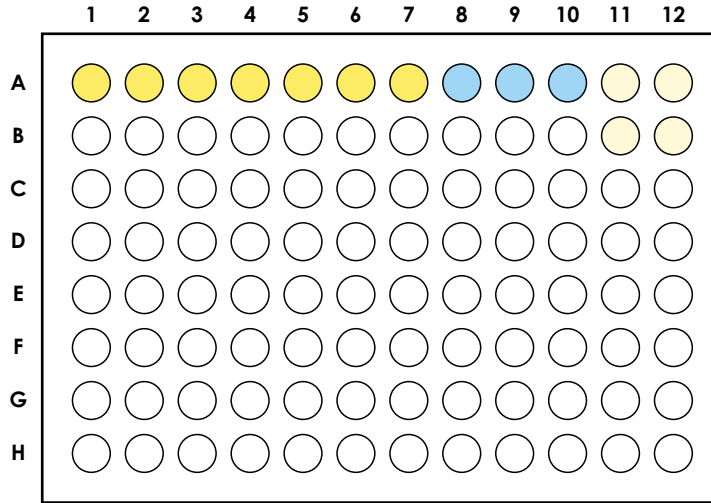
Test Procedure 2 – Micro plate format



-  **Positive control set**
-  **Negative control**
-  **Sample dilution set**

Note - Be sure to use an opaque polypropylene plate

Estimating the concentration of assimilable organic compounds in the tested water sample using the Excel module.

The module performs the following calculations automatically:

1. Calculate the average reading of the negative controls (ANC) and Standard Deviation (SD).
2. Subtract the ANC from all readings.
3. Calculate the minimal concentration of the tested water (in %) that exhibited an increase of (3xSD) in luminescence over the control. Note that the water concentration in vial #1 – 87.5%; vial #2 – 43.75%, etc.
4. Determine the (3xSD) of the Carbon Cocktail Standard by graphically plotting the luminescence obtained in each sample against its concentration. The detected sensitivity should be around 10-20 ppb.
5. The (3xSD) values obtained for the tested sample and the standard solution are defined as having an equivalent AOC value. Thus, for example, if 10% water and 20ppb Carbon Cocktail Solution were defined as the (3xSD) concentrations, the AOC of the water in question is said to contain $20\text{ppb} \times 10 = 0.2\text{ppm}$ Carbon equivalent units.
6. In order to convert carbon equivalent units into the commonly used AOC units (or acetate/Liter), one should run several samples in both Standard and CheckLight methods to determine the correlative coefficient factor for all future tests with that water source. Alternatively, one could regard the carbon equivalent units as arbitrary units for comparison between AOC values obtained from different water sources.

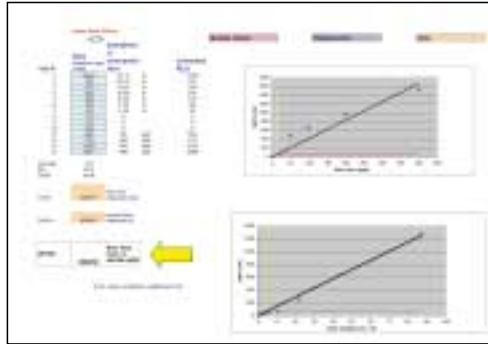

- Notes:**
- When calculating the AOC levels choose the time point that exhibits the optimum sensitivity as compared to the Standard. Do not calculate the average obtained at different reading time points.
 - If one of the three negative control tubes exhibits a result that is significantly different than the other two, discard that result and calculate the average in the remaining two tubes.
 - Hydrate the bacteria in cold Hydration Buffer
 - When running a large number of samples take a reading of the controls at the beginning and end of the process as luminescence may increase with time. Do not run more than 10 samples at a time.

Dechlorination of water samples

The presence of chlorine and its byproducts lead to rapid decay of bacterial bioluminescence. The provided Assay Buffer solution already contains sodium thiosulfate at a concentration that could chelate up to 2ppm of residual chlorine. Higher concentrations of chlorine should be properly diluted in clean water prior to addition of thiosulfate, or removed by other means.

4-Troubleshooting

Problem	Possible Fault	Corrective action
Inconsistent results	<ul style="list-style-type: none">• Inaccurate pipetting of reagents• Insufficiently mixed• Inconsistent incubation time and temperature	<ul style="list-style-type: none">• Make sure not to draw air bubbles• Make sure to use a repeat dispenser to aliquot the bacteria• Make sure to keep test conditions steady (e.g., incubation temperature, mixing, & reading time) Position luminometer next to water bath/incubator to reduce exposure to ambient temperature during reading.
Positive control (carbon cocktail solution) are not working	<ul style="list-style-type: none">• Improper dilution of the stock solution• Inaccurate dispensing of bacteria	<ul style="list-style-type: none">• Make sure the stock solution is prepared as instructed• Use a repeat dispenser to aliquot the bacteria
Sample readings exhibit inhibitory response (light level is lower than in negative control)	<ul style="list-style-type: none">• There is an element(s) in the sample whose inhibitory effect is stronger than the positive effect of the nutrients present in the sample.	<ul style="list-style-type: none">• Run "optional toxicity testing" procedure described on page 13.

5 - Frequently Asked Questions

Q: What is a bioassay?

A: A bioassay is a test that measures the degree to which a substance can elicit an effect in a given organism in order to detect the presence of that substance.

Q: How can luminous bacteria sense the presence of carbon?

A: Luminous bacteria emit measurable light as a by-product of cell respiration. The bacteria are given all the environmental and nutritional conditions necessary for light production, except an organic carbon source, instead of which the cells are exposed to the tested sample. The luminous bacteria are provided in a freeze-dried state. Upon hydration in the questioned water sample, these bacteria undergo prompt induction of the luminescence system if the sample contains assimilable organic compounds. Luminescence increases with time, with an intensity dependent on the concentration of the organic compound. Sub-ppm concentrations of different kinds of assimilable organic compounds can be determined within 2-3 hours.

Q: How does the test correlate with the standard van der Kooij method?

A: The graph depicts the correlation between the two tests using samples taken from different drinking water sources.

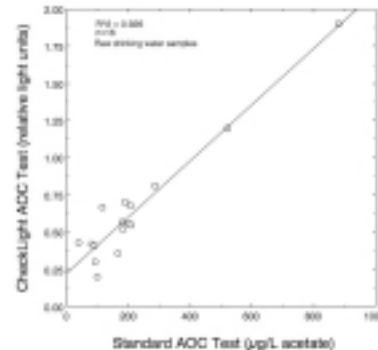

Q: Are luminous bacteria dangerous? Do I need to be a trained microbiologist in order to be able to conduct CheckLight's assays?

A: Luminous bacteria are not pathogenic and are harmless. No special skill is required to carry out the different tests other than very basic laboratory techniques (pipetting, dilutions etc) and equipment (pipettor, tips, luminometer).

Q: How might chlorinated water affect luminescence?

A: Chlorine is usually introduced into drinking water systems in order to avoid bacterial contamination. Since luminous bacteria used in the assay are also sensitive to this treatment, sodium thiosulfate is included in the assay buffer to dechlorinate the sample before adding the bacteria.

Q: Can I “play around” with the volumes of bacteria, buffers and other assay conditions?

A: No. It is extremely important to follow the test protocol instructions to the word. Since the test is very sensitive, any seemingly minor variations result in poor reliability.

Q: What is the shelf life of the reagents?

A: The shelf life of the freeze dried bacteria is one year when stored in a deep-freezer (-10° to -20°C). Reagent should not be stored in a self-defrosting freezer, which defrosts by warming up periodically. The assay buffers should be stored in a regular refrigerator (~4°C) and under no circumstances should they be frozen.

Q: Can I reuse the provided test vials?

A: Due to the high sensitivity of the assay, care should be taken to keep all vials, plastic tips, and pipettes extremely clean. Do not reuse test vials and do not wash glassware pipettors or pipette tips with detergent, acid, or solvents.



P.O.Box 72 Qiryat-Tivon 36000, Israel
Tel: +972 4 9930530, Fax: +972 4 9533176
www.checklight.biz
